

# GFS-400-KT SOLAR STREET LIGHT KIT

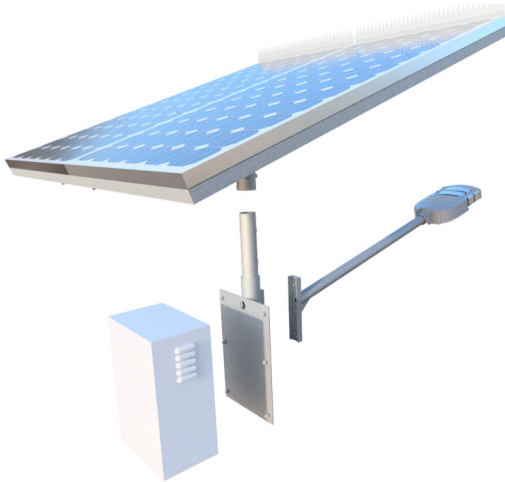

<b>CCT</b> <b>4000K</b> COLOUR TEMPERATURE	<b>LED</b> <b>187 LPW</b> <b>CREE</b> <b>XP-G</b>	<b>CONTROLLER</b> <b>99% MPPT</b>  EFFICIENCY	<b>SOLAR PANEL</b> <b>550W(p)</b>  25 YEAR WARRANTY	<b>PROTECTION</b> <b>INBUILT</b> <b>BMS</b> SYSTEM	<b>BATTERY LIFE</b> <b>UP TO</b> <b>60</b> HOURS	<b>WARRANTY</b> <b>5</b> YEAR UNIT WARRANTY*	<b>OPERATING TEMP</b> <b>-20°C-60°C</b> <b>-4°F-140°F</b> 
--	--	--	--	---	---	--	---



**LED:** 42 x CREE XP-G LED configured in 3 x 14 LED arrangements  
**OPERATION:** Average of 14 hrs per night with 5 nights backup  
**RESISTANCE:** IP65 construction with IP68 waterproof connectors  
**CONTROLLER:** MPPT solar charge controller with programmable ON / OFF setting (dusk to dawn) 1-14 hours ON / 1-14 hours OFF  
**BATTERIES:** 2 x sealed GEL AGM 12v 110Ah (220Ah - 1800Wh)  
**SOLAR PANELS:** 2 x 225W(p) mono-crystalline panels with tempered glass and reinforced frame and backing plate on underside of solar panel  
**LAMP OUTPUT:** 60W=11,220lm / 75W=14,025lm / 100W=18,700lm  
**WARRANTY:** Solar panel 25yr / Battery 5 yr pro rata warranty\*

## PHOTOMETRICS

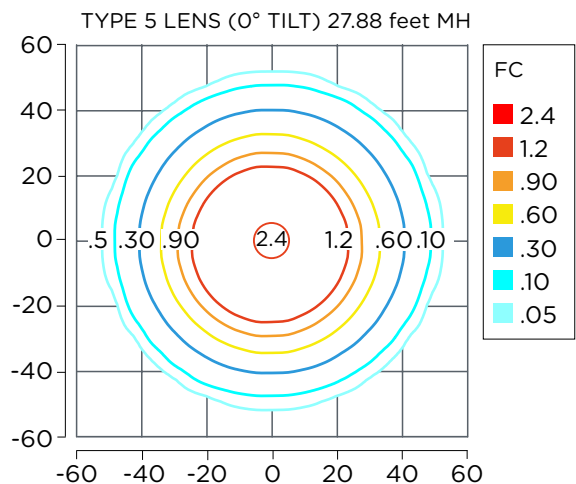
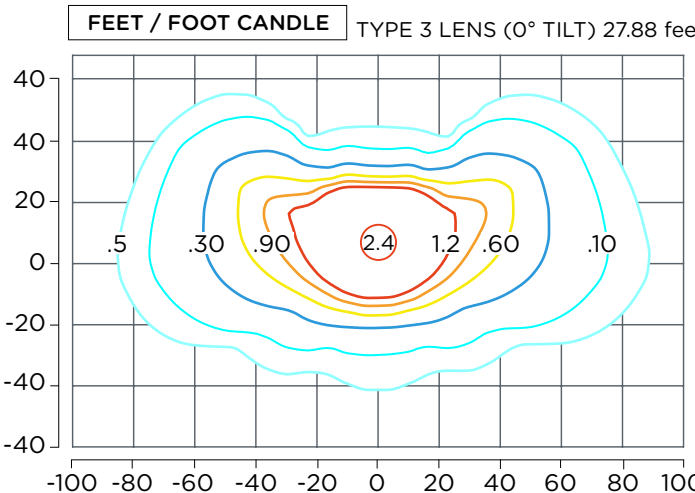
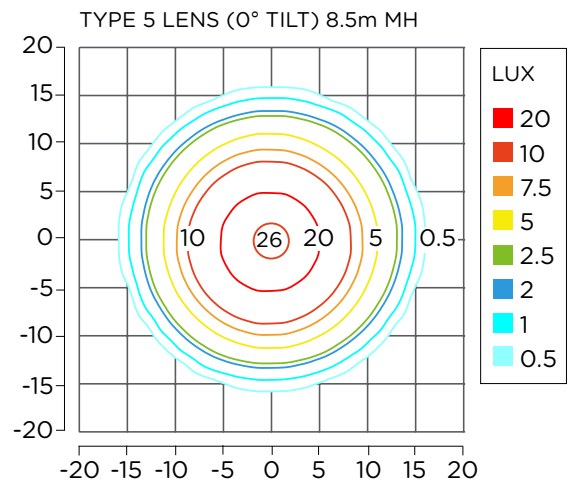
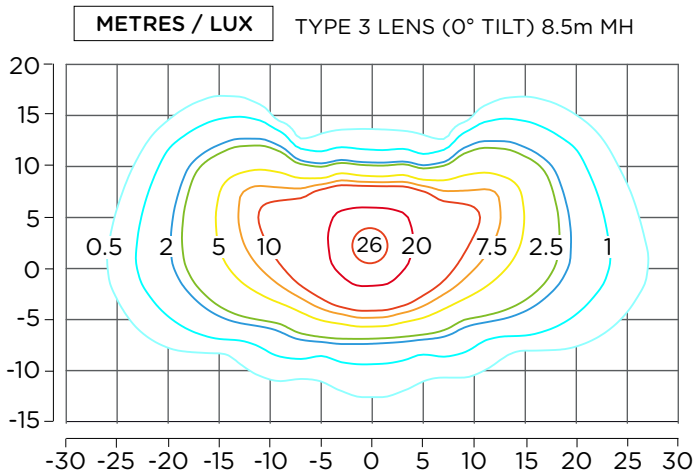

# GFS-400-KT SOLAR STREET LIGHT KIT



LED	
42 x CREE XP-G LED configured in 3 x 14 LED banks (USA made)	
60W = 11,220lm / 75W = 14,025lm / 100W = 18,700lm MAX.	
4000K CCT, 70 CRI 187lm/W	
Tilttable LED angles - 0° / 15° / 30°	
Dual LED module for redundancy	
Constant LED power output ensures consistent output all night	
LENS	
Impact resistant (IK10) polycarbonate lens allows for evenly distributed illumination	
Dual lens design offering lens mixing. (Type 3 / 5)	
<ul style="list-style-type: none"> <li>Type 3 (standard) - bat wing (pathway) lens 135° x 85°</li> <li>Type 5 (optional) - spherical (round) lens 110° x 135°</li> </ul>	
SOLAR PANEL	
450W(p) total mono-crystalline panels with 21% cell efficiency	
Impact resistant tempered glass solar panel assembly with protective stone guard plate on back of panel as standard.	
Anti bird spike rail (STANDARD) / stone guard (OPTIONAL)	
Fixed 20° angle with 360° horizontal solar panel rotation	
BATTERY	
Deep cycle sealed GEL AGM batteries	
2 x 12V - 110Ah, (2640Wh)	
5 nights backup power** (60hours @ 60W)	
SOLAR CHARGE CONTROLLER	
100% All Night (60W, 11,220 lumen) custom programing available. NOTE: 60W and 75W Requires custom programing or dimming profile to maintain reliability and battery life	
Monitors system vitals - LED / solar / battery & temperature	
In built soft start constant current LED driver with over voltage, over current and short circuit protection	
MPPT (maximum power point tracking) charging with 99% tracking efficiency	
IOT Smart city ready using GFS-SAM monitoring system***	
Programmable turn on hours, before sunrise	
OPERATING TEMPERATURE	
-20°C to 60°C / -4°F to 140°F	
SAIL AREA / EPA	
Solar panel assembly: 1.1m <sup>2</sup> / 11.84FT <sup>2</sup>	
Outrigger: 0.095m <sup>2</sup> / 1.02FT <sup>2</sup>	
LED Fixture: 0.085m <sup>2</sup> / 0.91FT <sup>2</sup>	
STANDARD MOUNTING HEIGHT	
LED 8.5m / 17.71FT above grade	
LIGHT HEAD/FIXTURE SIZE	
540 L x 310 W x 90 H mm / 21" L x 12.25" W x 3.25" H	

**	Days backup is calculated on a 12 hour night time operation @ 5610 lumens
***	When fitted with optional GFS-SAM control system
****	GFS does NOT guarantee lighting performance due to factors outside of GFS control such as shading, dirt, bird fouling etc. Battery performance may reduce in very low temperatures without reducing the cycle life.

CERTIFICATIONS			
ISO 9001:2015 QUALITY ASSURED COMPANY			
ASNZS 1158.3.1 Pedestrian area (Category P) lighting			
Product and component certifications listed UL E349212 LED, UL3135 Cabling, UL1598 Safety Luminaires, UL8750 LED Safety			
Certified to meet ANSI/IES RP-8-14 and ANSI/IES RP-20-14 lighting standards			
3.1 P1-P12, AS60598 Australian Certified LED			
FOOTPRINT			
1513 x 1618mm / 59.6" x 69.7" excluding outrigger			
SYSTEM WEIGHT			
GFS-400 Solar panel and mounting hardware: 69kg / 152lb			
Outrigger: 8kg / 17.6lb			
Lighthead: 6.5kg / 14.3lb			
Total system weight: 83.5kg / 183.7lb			
Battery box backing plate: 9kg / 19.8lb			
Stainless steel battery box (OPTIONAL): 29kg / 63.9lb			
Batteries (110Ah) each x 2: 29kg / 63.9lb			
Outrigger adaptor: 14kg / 30.9lb			
Vandal resistant battery box plates: 16kg / 35.2lb			
Battery box mounting plates (for mid pole mount): 5kg / 11.0lb			
Crate: 1680 x 1640 x 570 mm / 66" x 64.6" x 22.4"			
Top pole: 4500 x 130 x 130 mm / 118.1" x 5.1" x 5.1"			
Bottom pole: 4500 x 510 x 310 mm / 118.1" x 20" x 12.2"			
WARRANTY			
UNIT WARRANTY	BATTERY PERFORMANCE		
Solar Panel	25 Years	Base Warranty Period (Below 50% of original capacity design)	3 years
Mounting Bracket	5 Years		
LED Light Fixture	5 Years	37-48 months from purchase date	75% off Standard Price
Electronics	5 Years	49-60 months from purchase date	50% off Standard Price
Battery Defect Warranty	5 Years*		
*Full warranty details are on our website at <a href="http://greenfrogsystems.com.au/warranty">greenfrogsystems.com.au/warranty</a>			

## MOUNTING OPTIONS

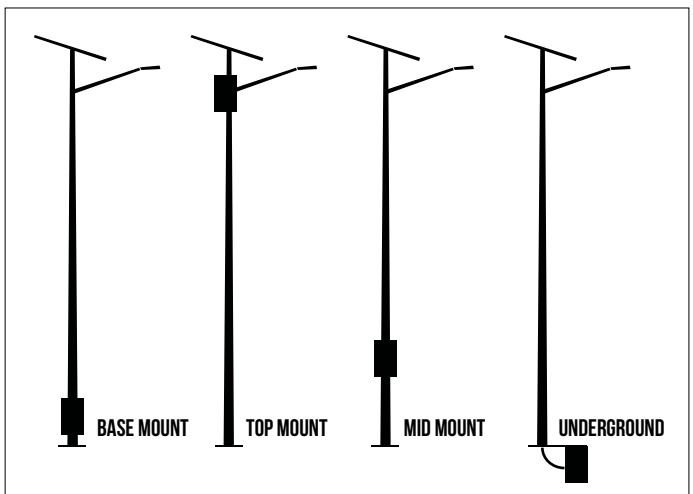

# GFS-400-KT SOLAR STREET LIGHT KIT



## LIGHT DISTRIBUTION

### FRONT VIEW

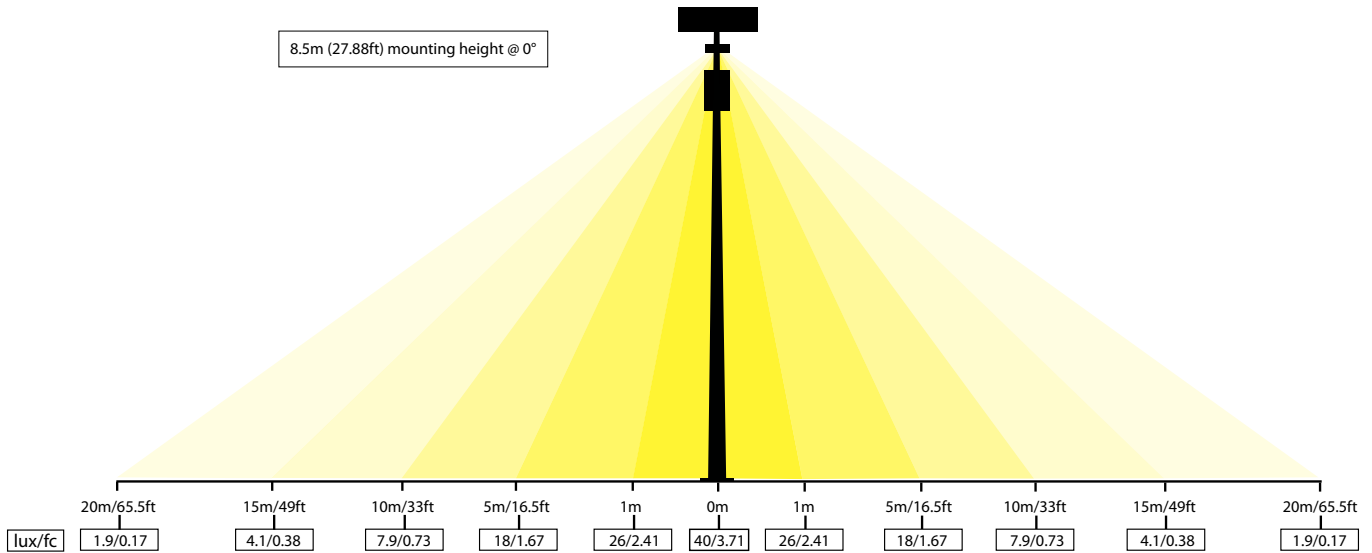

### SIDE VIEW

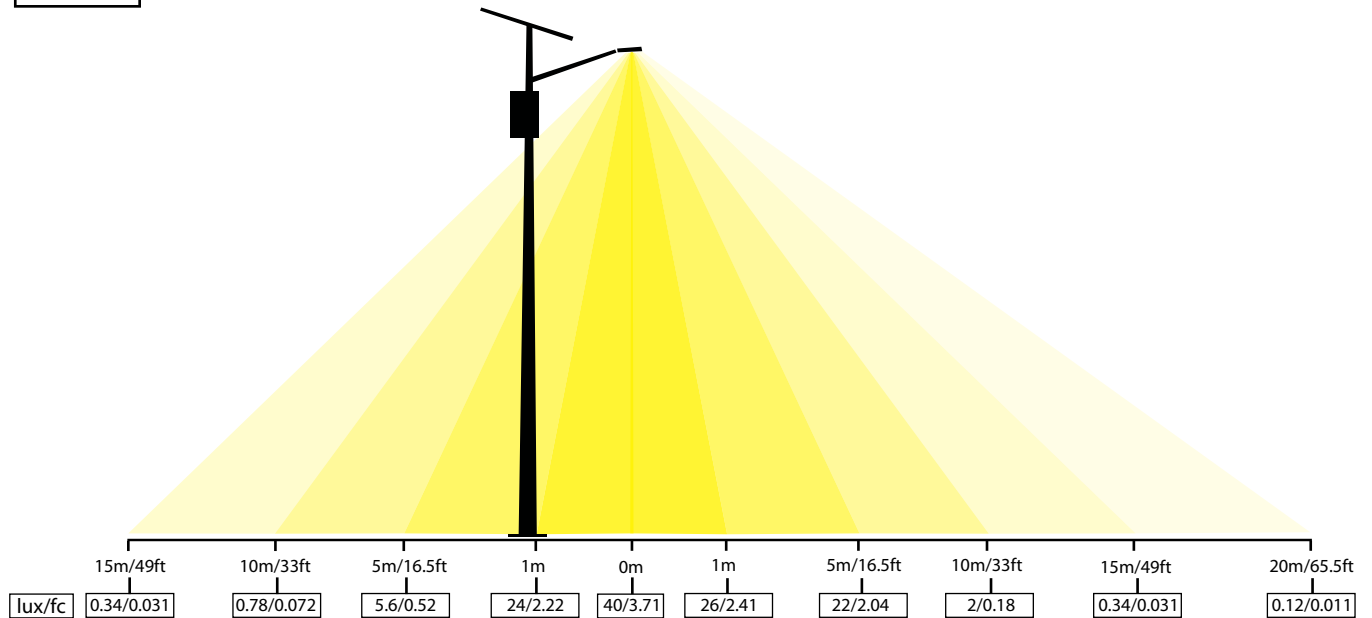

# GFS-400-KT SOLAR STREET LIGHT KIT



## PRODUCT DIMENSIONS

### KIT CONTENTS INCLUDE :

1. Instruction Manual
  2. Serial Number Plate
  3. Wooden Packing Crate
- Solar Panel Assembly
  - LED Light
  - Light Arm
  - Light Cable Extension
  - Bird Guard
  - Batteries (x2)
  - Solar Controller

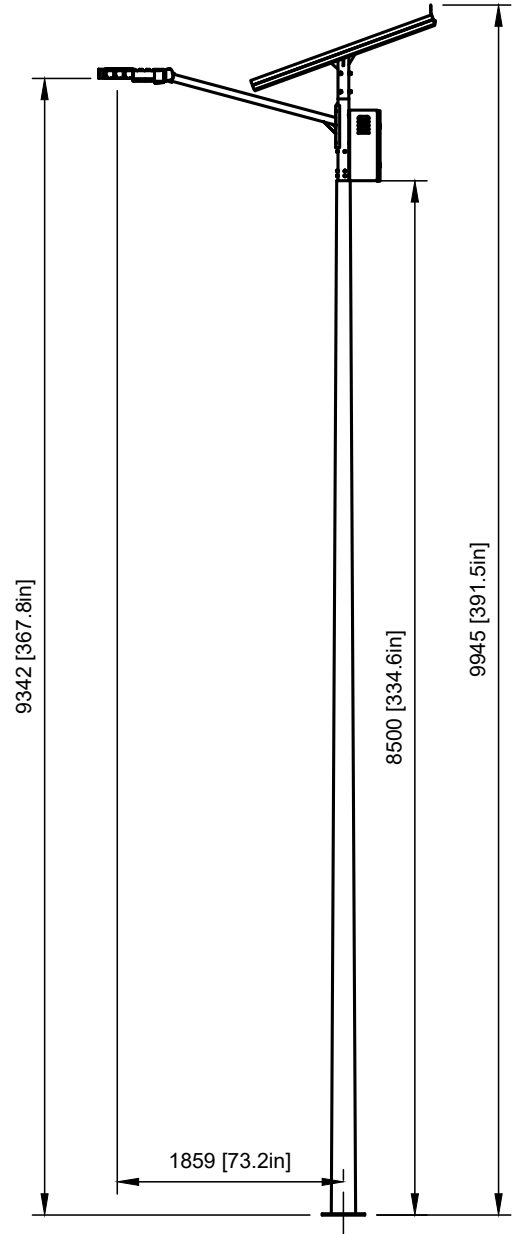
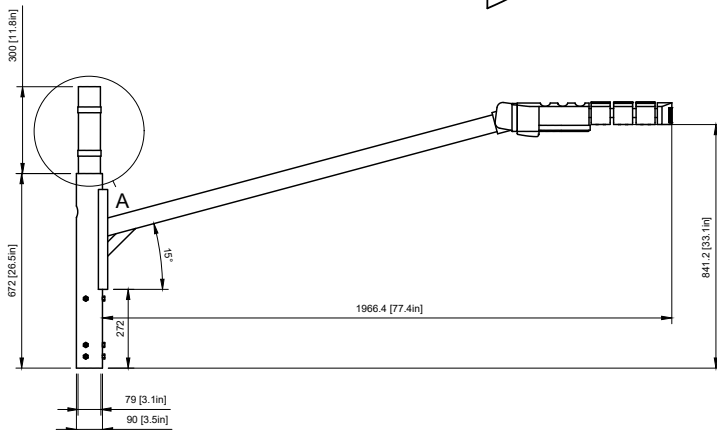
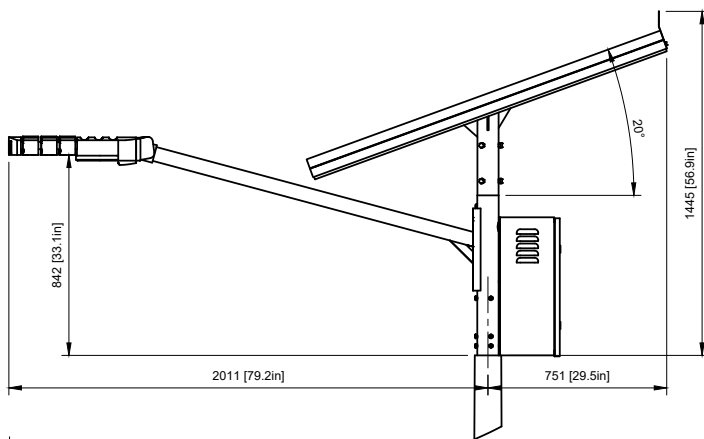
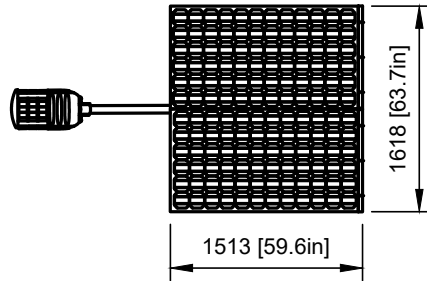

A (1:3)

